

# Verktøyvogn og skumstoffinnlegg

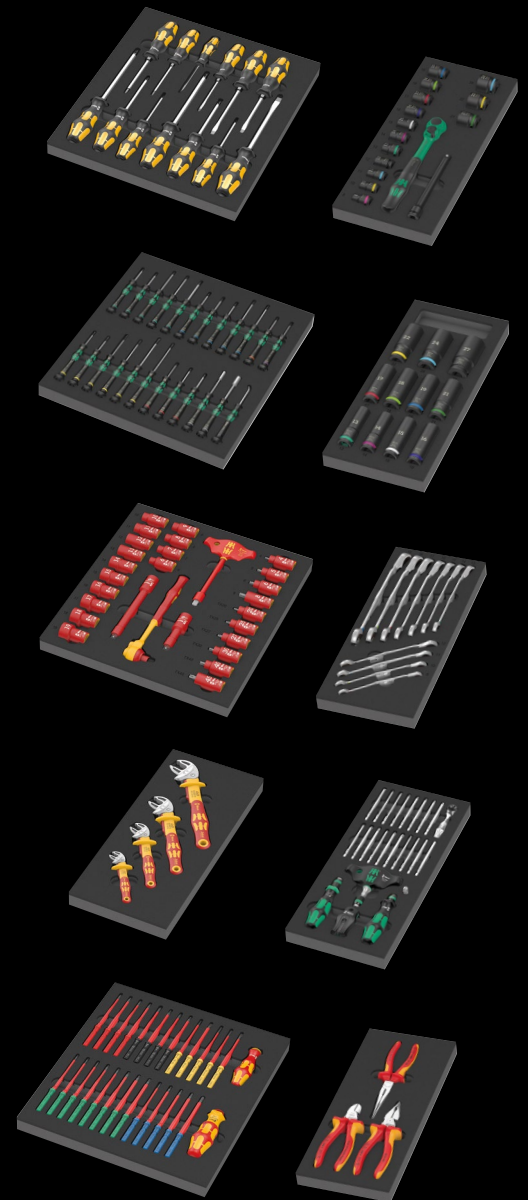

## Verktøyvogn med innhold og genial frontutførelse av ypperste kvalitet.

- Eksklusiv verktøyvogn i Tool Rebel-utførelse
- Ekstremt robust utførelse takket være dobbeltvegget konstruksjon
- Med 7 skuffer (5 lave, 2 høye) – hvorav 2 lave skuffer med skumstoffinnlegg og verktøy
- Mål lave skuffer (bredde x høyde x dybde): 522 x 81 x 398 mm
- Mål høye skuffer (bredde x høyde x dybde): 522 x 166 x 398 mm
- 100 % skuffeuttrekk med kulelagrede teleskopskinner, selvinntrekk
- Alle skuffer er grundig foliert enkeltvis
- Minimal veltefare takket være uttrekkssperre – kun én skuff kan åpnes, flere skuffer kan ikke trekkes ut samtidig
- Høykvalitets skumstoffinnlegg med lang levetid og uten kjemisk avdunsting
- Optimal tilpasning for å gjøre det enklest mulig å ta ut verktøyene fra skumstoffinnleggene





## 9700 Tool Rebel verktøyvogn 1



Eksklusiv verktøyvogn i Tool Rebel-utførelse. 5 lave og 2 høye skuffer sørger for effektiv og mobil organisering av verktøy og materiell. Ekstremt robust takket være dobbeltvegget utførelse og helsveist skrogkonstruksjon. For daglig, hard bruk på verkstedet. Utstyrt med 4 Wera skumstoffinnlegg: 9710 Skumstoffinnlegg skrutrekkere sett 1, 9720 Skumstoffinnlegg 8000 A Zy-klop-skraller sett 1, 9731 Skumstoffinnlegg 6003 Joker kombinasjonsnøkler sett 1, 9740 Skumstoffinnlegg vinkeløkler sett 1.

05150130001 1x 9700 Tool Rebel verktøyvogn 1

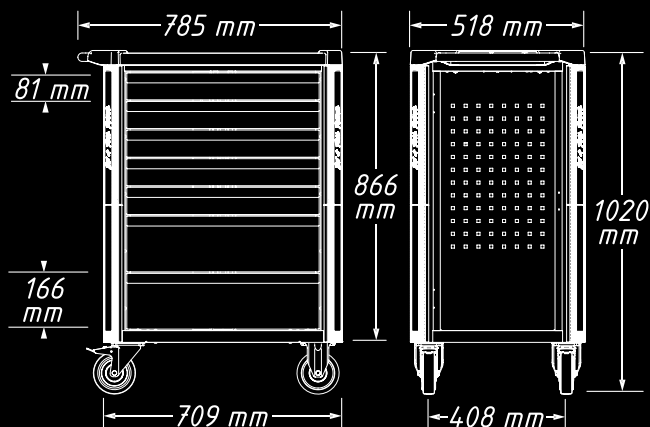

## Inkludert i følgende skumstoffinnlegg:

9710



9720

1/4"

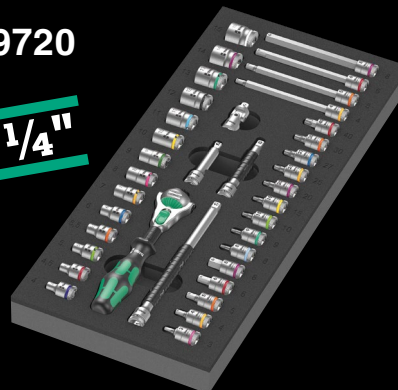

9731



9740



## NYHET

### 9714 Skumstoffinnlegg skruemel skrutrekker sett 1

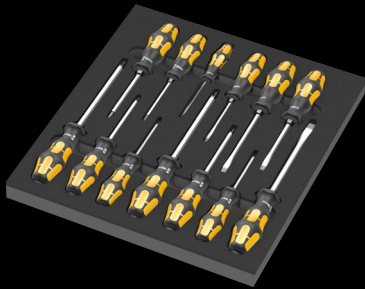

05150105001		
+	917 SPH	1x PH 1x80; 1x PH 2x100; 1x PH 3x150
+	918 SPZ	1x PZ 1x80; 1x PZ 2x100; 1x PZ 3x150
-	932 A	1x 0,6x3,5x80 <sup>1)</sup> ; 1x 0,8x4,5x90; 1x 1,0x5,5x100; 1x 1,2x7,0x125; 1x 1,6x9,0x150
+	977 TORX®	1x TX 20x90; 1x TX 25x100
	9814	1x 344,0x30,0x392,0

<sup>1)</sup> Ikke gjennomgående klinger, ikke slagkappe og sekskant for fastnøkkel

## NYHET

### 9715 Skumstoffinnlegg skrutrekker Kraftform Micro sett 1

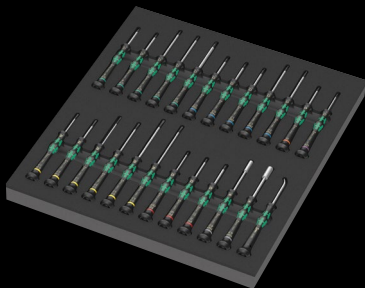

05150106001		
+	2050 Micro	1x PH 000x40 <sup>1) 2)</sup> ; 1x PH 00x40 <sup>1) 2)</sup> ; 1x PH 0x40 <sup>3)</sup>
+	2067 TORX® HF	1x TX 5x40; 1x TX 6x40; 1x TX 7x60; 1x TX 8x60; 1x TX 10x60
+	2067 TORX PLUS® IPR Micro	1x 1 IPRx40 <sup>4)</sup>
+	2072 Micro	1x mx40
○	2054 Micro	1x 0,7x40; 1x 0,9x40; 1x 1,3x40; 1x 1,5x60; 1x 2x60
-	2035 Micro	1x 0,23x1,5x40; 1x 0,30x1,8x60; 1x 0,35x2,5x40; 1x 0,40x2,0x60; 1x 0,40x2,5x80; 1x 0,50x3,0x80
●	2069 Micro	1x 4,0x60; 1x 5,5x60
●	1429	1x 1,0x3,5x50
	9815	1x 344,0x30,0x392,0

<sup>1)</sup> Optimert for asiatiske PH-skruer

<sup>2)</sup> Klinge dreiet ned til nominell dimensjon på arbeidssiden i en lengde på 10 mm

<sup>3)</sup> Størrelse 0 modifisert i henhold til JCI 0 (japansk bransjestandard for kameraer)

<sup>4)</sup> Uten hull

## NYHET

### 9726 Skumstoffinnlegg 8007 B VDE Zyklop VDE skrallesett 1, 3/8"



05150116001		
○	8007 B VDE	1x 3/8"x222,0
○	410 i VDE B	1x 3/8"x130
●	8790 B VDE	1x 6,0x46,0; 1x 7,0x46,0; 1x 8,0x46,0; 1x 9,0x46,0; 1x 10,0x46,0; 1x 11,0x46,0; 1x 12,0x46,0; 1x 13,0x46,0; 1x 14,0x46,0; 1x 15,0x46,0; 1x 16,0x46,0; 1x 17,0x46,0; 1x 18,0x46,0; 1x 19,0x46,0
+	8767 B VDE HF	1x TX 20x55,0; 1x TX 25x55,0; 1x TX 27x55,0; 1x TX 30x55,0; 1x TX 40x55,0; 1x TX 45x59,0
○	8740 B VDE HF	1x 4,0x55,0; 1x 5,0x55,0; 1x 6,0x55,0; 1x 8,0x59,0
○	8794 SB VDE	1x 3/8"x91,0
○	8794 LB VDE	1x 3/8"x166,0
	9826	1x 344,0x30,0x392,0

## NYHET

### 9734 Skumstoffinnlegg 6004 Joker VDE sett 1



05150124001		
	6004 Joker VDE XS	1x 7-10 (1/4"-3/8")x119
	6004 Joker VDE S	1x 10-13 (7/16"-1/2")x155
	6004 Joker VDE M	1x 13-16 (1/2"-5/8")x190
	6004 Joker VDE L	1x 16-19 (5/8"-3/4")x226
	9834	1x 172,0x30,0x392,0

**OBS! Skumstoffinnleggene passer ikke i den foregående modellen 05501051001 av verktøylvognen.**

## NYHET

### 9751 Skumstoffinnlegg Kraftform Kompakt VDE sett 1

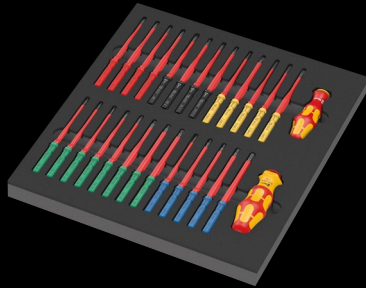

05150151001		
●	837 i RA	1x 9x115
●	817 VDE	1x 9x98
⊕	Kraftform Kompakt VDE 62 iS Take it easy	1x PH 1x157; 1x PH 2x157
⊕	Kraftform Kompakt VDE 65 iS Take it easy	1x PZ 1x157; 1x PZ 2x157
⊕	Kraftform Kompakt VDE 62 iS PH/S Take it easy	1x # 1x157; 1x # 2x157
⊕	Kraftform Kompakt VDE 65 iS PZ/S Take it easy	1x # 1x157; 1x # 2x157
⊕	Kraftform Kompakt VDE 67 i Take it easy	1x TX 8x157; 1x TX 9x157; 1x TX 10x157; 1x TX 27x157; 1x TX 30x157
⊕	Kraftform Kompakt VDE 67 iS Take it easy	1x TX 15x157; 1x TX 20x157; 1x TX 25x157
○	Kraftform Kompakt VDE 64 i Take it easy	1x 2,5x157; 1x 3,0x157; 1x 4,0x157; 1x 5,0x157; 1x 6,0x157
⊖	Kraftform Kompakt VDE 60 iS Take it easy	1x 0,6x3,5x157; 1x 0,8x4,0x157; 1x 1,0x5,5x157
⊖	Kraftform Kompakt VDE 60 i Take it easy	1x 0,4x2,5x157; 1x 1,2x6,5x157
	9851	1x 344,0x30,0x392,0

## NYHET

### 9724 Skumstoffinnlegg 8010 B Zyklop Comfort skrallssett 1, 3/8"



3/8"



05150114001		
○	8010 B	1x 3/8"x230,0
●	8790 B Impaktor	1x 8,0x30,0; 1x 10,0x30,0; 1x 11,0x30,0; 1x 12,0x30,0; 1x 13,0x30,0; 1x 14,0x30,0; 1x 15,0x30,0; 1x 16,0x30,0; 1x 17,0x30,0; 1x 18,0x30,0; 1x 19,0x30,0; 1x 21,0x32,0; 1x 22,0x32,0; 1x 24,0x32,0
●○	8798 B	1x 3/8"x152,4
	9824	1x 172,0x30,0x392,0

## NYHET

### 9725 Skumstoffinnlegg Zyklop C, 1/2", Impaktor Deep pipenøkkelsett 1



05150115001		
●	8790 C Impaktor Deep	1x 13,0x83,0; 1x 14,0x83,0; 1x 15,0x83,0; 1x 16,0x83,0; 1x 17,0x83,0; 1x 18,0x83,0; 1x 19,0x83,0; 1x 21,0x83,0; 1x 22,0x83,0; 1x 24,0x83,0; 1x 27,0x83,0
	9825	1x 172,0x30,0x392,0

## NYHET

### 9733 Skumstoffinnlegg 6001 Joker Switch sett 1

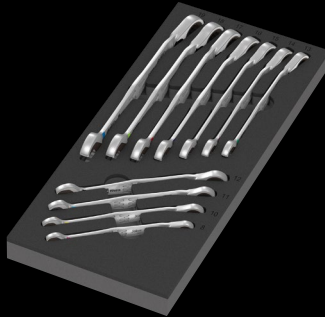

05150123001	
6001 Joker Switch	1x 8x144; 1x 10x159; 1x 11x165; 1x 12x171; 1x 13x179; 1x 14x187; 1x 15x199; 1x 16x213; 1x 17x225; 1x 18x234; 1x 19x246
9833	1x 172,0x30,0x392,0

## NYHET

### 9784 Skumstoffinnlegg KNIPEX tenger sett VDE 1



05150184001	
KNIPEX sidekniv 70 06 160	
KNIPEX flatrundtang med skjær (storknebbtang) 26 16 200	
KNIPEX spiss kombinasjontang 08 26 185	
9884	1x 172,0x30,0x392,0

## NYHET

### 9752 Skumstoffinnlegg Kraftform Kompakt med skrallfunksjon sett 1



1/4"

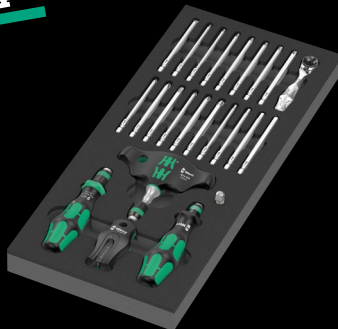

05150152001	
838 RA-R M	1x 1/4"x123,5
416 RA	1x 1/4"x45
816 R	1x 1/4"x119
8001 A	1x 1/4"x87,0
851/4 Z	1x PH 1x89; 1x PH 2x89; 1x PH 3x89 <sup>1)</sup>
855/4 Z	1x PZ 1x89; 1x PZ 2x89; 1x PZ 3x89 <sup>1)</sup>
867/4 Z TORX®	1x TX 10x89; 1x TX 15x89; 1x TX 20x89; 1x TX 25x89; 1x TX 27x89; 1x TX 30x89; 1x TX 40x89
840/4 Z	1x 3,0x89; 1x 4,0x89; 1x 5,0x89; 1x 6,0x89 <sup>1)</sup>
800/4 Z	1x 1,0x5,5x89
870/1	1x 1/4"x25 <sup>2)</sup>
9500	1x 64,6
9852	1x 172,0x30,0x392,0

### 9710 Skumstoffinnlegg skrutrekker sett 1



05150101001	
932 A	1x 1,0x5,5x100; 1x 1,2x7,0x125
350 PH	1x PH 1x80; 1x PH 2x100; 1x PH 3x150
350 PH Stubby	1x PH 2x25
355 PZ	1x PZ 1x80; 1x PZ 2x100
335	1x 0,8x4,0x100; 1x 1,0x5,5x125
334	1x 1,2x6,5x150
335 Stubby/ forgasser-skrutrekker	1x 1,0x5,5x24,5
2050 Micro	1x PH 0x40 <sup>1)</sup>
2035 Micro	1x 0,40x2,5x80
160 i VDE	1x 0,4x2,5x80 <sup>2)</sup> ; 1x 0,6x3,5x100 <sup>2)</sup>
1441	1x 4,5-6,0x41,0
1442	1x 6,0-8,5x41,0
9810	1x 344,0x30,0x392,0

<sup>1)</sup> Størrelse 0 modifisert i henhold til JCI 0 (japansk bransjestandard for kameraer)

<sup>2)</sup> uten Lasertip

<sup>1)</sup> Sekskantklunge

<sup>2)</sup> Med kule, for manuelt feste av piper

## 9711 Skumstoffinnlegg VDE-skrutrekere sett 1

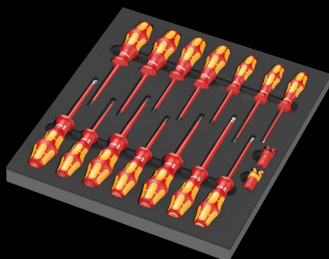

05150102001	
+	<b>162 iS PH VDE</b> 1x PH 1x80; 1x PH 2x100
+	<b>165 iS PZ VDE</b> 1x PZ 1x80; 1x PZ 2x100
+	<b>165 i PZ/S VDE</b> 1x # 2x100
-	<b>160 i VDE</b> 1x 0,4x2,5x80 <sup>1)</sup> ; 1x 0,8x4,0x100; 1x 1,0x5,5x125
-	<b>160 iS VDE</b> 1x 0,6x3,5x100
+	<b>167 i TORX® VDE</b> 1x TX 10x80; 1x TX 15x80; 1x TX 20x80; 1x TX 25x100; 1x TX 30x100
	<b>1440</b> 1x 4,5-6,0x41,0
	<b>1442</b> 1x 6,0-8,5x41,0
	<b>9811</b> 1x 344,0x30,0x392,0

<sup>1)</sup> uten Lasertip

## 9713 Skumstoffinnlegg sekskantskrutrekere sett 1

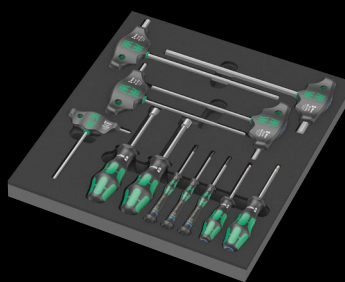

05150104001	
○	<b>354</b> 1x 3,0x75; 1x 4,0x75
○	<b>2054 Micro</b> 1x 1,5x60; 1x 2x60; 1x 2,5x60
○	<b>454 HF</b> 1x 4x100; 1x 5x100; 1x 6x150; 1x 8x200; 1x 10x200
●	<b>395 H0</b> 1x 10,0x90; 1x 13,0x90
	<b>9813</b> 1x 344,0x30,0x392,0

## 9720 Skumstoffinnlegg 8000 A Zyklus skraller 1/4" sett 1



## 9712 Skumstoffinnlegg TORX® HF skrutrekere sett 1

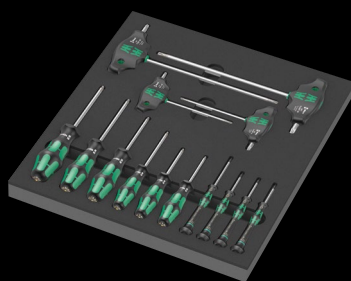

05150103001	
+	<b>367 TORX® HF</b> 1x TX 8x60; 1x TX 9x60; 1x TX 10x80; 1x TX 15x80; 1x TX 20x100; 1x TX 25x100
+	<b>2067 TORX® HF</b> 1x TX 4x40; 1x TX 5x40; 1x TX 6x40; 1x TX 7x60
+	<b>467 TORX® HF</b> 1x TX 20x100; 1x TX 25x100; 1x TX 30x200; 1x TX 40x200
	<b>9812</b> 1x 344,0x30,0x392,0

05150110001	
○	<b>8000 A</b> 1x 1/4"x152,0
●○	<b>8794 LA</b> 1x 1/4"x150,0
●○	<b>8794 SA</b> 1x 1/4"x75,0
●○	<b>8795 A</b> 1x 1/4"x35,5
●○	<b>8794 A</b> 1x 1/4"x56,0
●	<b>8790 HMA</b> 1x 4,0x23,0; 1x 4,5x23,0; 1x 5,0x23,0; 1x 5,5x23,0; 1x 6,0x23,0; 1x 7,0x23,0; 1x 8,0x23,0; 1x 9,0x23,0; 1x 10,0x23,0; 1x 11,0x23,0; 1x 12,0x23,0; 1x 13,0x23,0; 1x 14,0x23,0; 1x 15,0x23,0
+	<b>8767 A HF</b> 1x TX 8x28,0; 1x TX 9x28,0; 1x TX 10x28,0; 1x TX 15x28,0; 1x TX 20x28,0; 1x TX 25x28,0; 1x TX 27x28,0; 1x TX 30x28,0; 1x TX 40x28,0
○	<b>8740 A HF</b> 1x 3,0x28,0; 1x 4,0x28,0; 1x 4,0x100,0; 1x 5,0x28,0; 1x 5,0x100,0; 1x 6,0x28,0; 1x 6,0x100,0; 1x 8,0x28,0; 1x 8,0x100,0
	<b>9820</b> 1x 172,0x30,0x392,0



## 9721 Skumstoffinnlegg 8000 B Zyklop skraller 3/8" sett 1



3/8"



05150111001		
○	8000 B	1x 3/8"x199,0
●○	8794 SB	1x 3/8"x125,0
●○	8794 LB	1x 3/8"x200,0
●○	8795 B	1x 3/8"x50,0
●○	8794 B	1x 3/8"x76,0
●	8790 HMB	1x 6,0x29,0; 1x 7,0x29,0; 1x 8,0x29,0; 1x 9,0x29,0; 1x 10,0x29,0; 1x 11,0x29,0; 1x 12,0x29,0; 1x 13,0x29,0; 1x 14,0x29,0; 1x 15,0x29,0; 1x 16,0x30,0; 1x 17,0x30,0; 1x 18,0x30,0; 1x 19,0x30,0; 1x 20,0x30,0; 1x 21,0x30,0; 1x 22,0x30,0; 1x 24,0x32,0
	9821	1x 172,0x30,0x392,0

## 9723 Skumstoffinnlegg Zyklop B 3/8" pipebits sett 1



3/8"



05150113001		
●●	8784 B1	1x 1/4"x3/8"x44,0
⊗	8767 B HF	1x TX 15x35,0; 1x TX 20x35,0; 1x TX 25x35,0; 1x TX 25x107,0; 1x TX 27x35,0; 1x TX 27x107,0; 1x TX 30x35,0; 1x TX 30x107,0; 1x TX 40x35,0; 1x TX 40x107,0
○	8740 B HF	1x 4,0x35,0; 1x 4,0x107,0; 1x 5,0x35,0; 1x 5,0x107,0; 1x 6,0x35,0; 1x 6,0x107,0; 1x 7,0x38,5; 1x 8,0x38,5; 1x 8,0x100,0; 1x 10,0x38,5; 1x 10,0x100,0
	9823	1x 172,0x30,0x392,0

## 9722 Skumstoffinnlegg 8000 C Zyklop skraller 1/2" sett 1



1/2"



05150112001		
○	8000 C	1x 1/2"x277,0
●○	8794 LC	1x 1/2"x250,0
●○	8794 SC	1x 1/2"x125,0
●○	8795 C	1x 1/2"x69,0
●○	8794 C	1x 1/2"x52,0
●	8790 HMC	1x 10,0x37,0; 1x 11,0x37,0; 1x 12,0x37,0; 1x 13,0x37,0; 1x 14,0x37,0; 1x 15,0x37,0; 1x 16,0x37,0; 1x 17,0x37,0; 1x 18,0x37,0; 1x 19,0x37,0; 1x 20,0x37,0; 1x 21,0x37,0; 1x 22,0x37,0; 1x 24,0x37,0; 1x 27,0x40,0; 1x 30,0x42,0; 1x 32,0x42,0
○	8740 C HF	1x 4,0x60,0; 1x 4,0x140,0; 1x 5,0x60,0; 1x 5,0x140,0; 1x 6,0x60,0; 1x 6,0x140,0; 1x 7,0x60,0; 1x 8,0x60,0; 1x 10,0x60,0
	9822	1x 344,0x30,0x392,0

## 9730 Skumstoffinnlegg 6000 Joker sett 1



05150120001		
	6000 Joker	1x 8x144; 1x 10x159; 1x 11x165; 1x 12x170,7; 1x 13x177; 1x 14x188; 1x 15x200; 1x 16x212; 1x 17x224; 1x 18x235; 1x 19x246
	9830	1x 172,0x30,0x392,0

## 9731 Skumstoffinnlegg 6003 Joker sett 1



05150121001		
	<b>6003 Joker</b>	1x 6x105; 1x 7x110; 1x 8x115; 1x 9x120; 1x 10x125; 1x 11x135; 1x 12x148; 1x 13x160; 1x 14x167; 1x 15x174; 1x 16x182; 1x 17x190; 1x 18x210; 1x 19x230,0; 1x 20x230,0; 1x 21x260; 1x 22x260; 1x 24x280
	<b>Flaskeåpner</b>	1x 148
	<b>9831</b>	1x 344,0x30,0x392,0

## 9732 Skumstoffinnlegg 6004 Joker sett 1



05150122001		
	<b>6004 Joker XS</b>	1x 7-10 (1/4"-3/8")x117
	<b>6004 Joker S</b>	1x 10-13 (7/16"-1/2")x154
	<b>6004 Joker M</b>	1x 13-16 (1/2"-5/8")x188
	<b>6004 Joker L</b>	1x 16-19 (5/8"-3/4")x224
	<b>6004 Joker XL</b>	1x 19-24x (3/4"-15/16")x256
	<b>9832</b>	1x 172,0x30,0x392,0

## 9740 Skumstoffinnlegg vinkeløkler sett 1

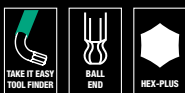

## 9750 Skumstoffinnlegg Kraftform Kompakt og Tool-Check PLUS sett 1



05150150001		
	<b>1x Tool-Check PLUS</b>	
	● <b>8001 A</b>	1x 1/4"x87.0
	● <b>813</b>	1x 1/4"x78
	● <b>889/4/1 K</b>	1x 1/4"x50
	○ <b>870/1</b>	1x 1/4"x25 <sup>1)</sup>
	● <b>8790 HMA</b>	1x 5.5x23.0; 1x 6.0x23.0; 1x 7.0x23.0; 1x 8.0x23.0; 1x 10.0x23.0; 1x 12.0x23.0; 1x 13.0x23.0
	⊕ <b>851/1 TZ</b>	2x PH 1x25; 3x PH 2x25; 1x PH 3x25
	⊕ <b>855/1 TH</b>	1x PZ 1x25; 3x PZ 2x25; 1x PZ 3x25
	⊕ <b>867/1 TZ TORX®</b>	1x TX 10x25; 1x TX 15x25; 1x TX 20x25; 1x TX 25x25; 1x TX 30x25; 1x TX 40x25
	⊕ <b>867/1 Z TORX® BO</b>	1x TX 10x25; 1x TX 15x25; 1x TX 20x25; 1x TX 25x25; 1x TX 30x25
	○ <b>840/1 Z</b>	1x 3.0x25; 1x 4.0x25; 1x 5.0x25; 1x 6.0x25; 1x 8.0x25
	⊖ <b>800/1 TZ</b>	1x 1.0x5.5x25
	<b>1x Kraftform Kompakt 60</b>	
	● <b>816 R</b>	1x 1/4"x119
	⊕ <b>851/4 Z</b>	1x PH 1x89; 1x PH 2x89; 1x PH 3x89 <sup>2)</sup>
	⊕ <b>855/4 Z</b>	1x PZ 1x89; 1x PZ 2x89; 1x PZ 3x89 <sup>2)</sup>
	⊕ <b>867/4 Z TORX® BO</b>	1x TX 10x89; 1x TX 15x89; 1x TX 20x89; 1x TX 25x89; 1x TX 30x89
	⊖ <b>800/4 Z</b>	1x 1.0x5.5x89
	○ <b>840/4 Z</b>	1x 3.0x89; 1x 4.0x89; 1x 5.0x89; 1x 6.0x89 <sup>2)</sup>
	<b>Krok og borrelås tape 70</b>	1x 50.0x70.0
	<b>1x 393 S</b>	
	●	1x 1/4"x173,5
	<b>1x 9850</b>	
		1x 172,0x30,0x392,0

<sup>1)</sup> Med kule, for manuelt feste av piper

<sup>2)</sup> Sekskantklinge

05150140001		
	<b>1x 950/9 Hex-Plus Multicolour 1</b>	
	○ <b>950 SPKL Multicolour</b>	1x 1.5x90; 1x 2.0x101; 1x 2.5x112; 1x 3.0x123; 1x 4.0x137; 1x 5.0x154; 1x 6.0x172; 1x 8.0x195; 1x 10.0x224
	<b>1x 967/9 TX XL Multicolour 1</b>	
	⊕ <b>967 SXL TORX® Multicolour</b>	1x TX 8x90; 1x TX 9x101; 1x TX 10x112
	⊕ <b>967 SPKXL TORX® Multicolour</b>	1x TX 15x123; 1x TX 20x137; 1x TX 25x154; 1x TX 27x172; 1x TX 30x195; 1x TX 40x224
	<b>1x 9500</b>	
		1x 64,6
	<b>1x STABILA® målebånd BM 100, 3 m, artikkel 19570</b>	
		1x 3000,0
	<b>1x 9840</b>	
		1x 172,0x30,0x392,0

### 9780 Skumstoffinnlegg KNIPEX tenger sett 1



05150180001		
	KNIPEX kombinasjonstang 03 05 180	1x 180
	KNIPEX Cobra® High-tech-vannpumpetang 87 05 250	1x 250
	KNIPEX Kraft-sideavbiter 74 05 160	1x 160
	9880	1x 172,0x30,0x392,0

### 9782 Skumstoffinnlegg hammere sett 1



05150182001		
	PICARD® ingeniørhammer 500 g, 0000101-500	1x 500,0
	RENNSTEIG drivdor 1x4520046RC, 4,0x150; 1x4520066RC, 6,0x150; utelukkende Exklusiv	1x 452 003 6 RC, 3,0x150; 1x 452 008 6 RC, 8,0x150
	RENNSTEIG flatmeisel 310 250 1	1x 25,0x13,0x23,0
	9882	1x 172,0x30,0x392,0

### 9781 Skumstoffinnlegg KNIPEX tenger sett 2

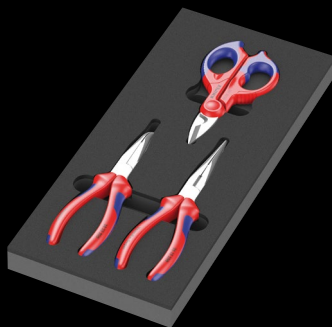

05150181001		
	KNIPEX nebbtang med skjær (Storknebbtang) 26 15 200	1x 200
	KNIPEX meka-nikertang 38 25 200	1x 200
	KNIPEX elektrikersaks 95 05 155	1x 155
	9881	1x 172,0x30,0x392,0

### 9783 Skumstoffinnlegg PFERD filer sett 1

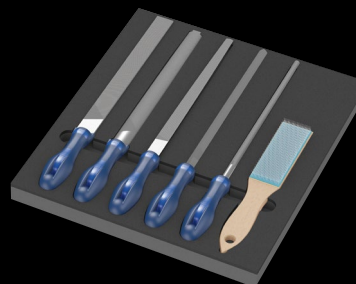

05150183001		
	PFERD verkstedfil firkant PF1142 250 H2	1x 250
	PFERD verkstedfil halv-rund-spiss 1152SP 250 H2	1x 250
	PFERD verkstedfil rund 1162 250 H2	1x 250
	PFERD verkstedfil flat stump 1112 250 H2	1x 250
	PFERD verkstedfil trekant 1132 250 H2	1x 250
	PFERD filbørste HBF ståltråd Ø 0,15	1x 232
	9883	1x 344,0x30,0x392,0

Vi forbeholder oss retten til å endre opplysninger vedrørende produktenskaper, versjoner og utførelser i denne katalogen uten forhåndsvarsel. Med forbehold om trykkfeil og andre typer feil.



Wera Werkzeuge GmbH  
Korzenter Straße 21-25  
D-42349 Wuppertal  
Germany

Phone: +49 (0)2 02/40 45-0  
E-Mail: [info@wera.de](mailto:info@wera.de)  
[www.wera.de](http://www.wera.de)