

# Carrello da officina e termoformati in spugna

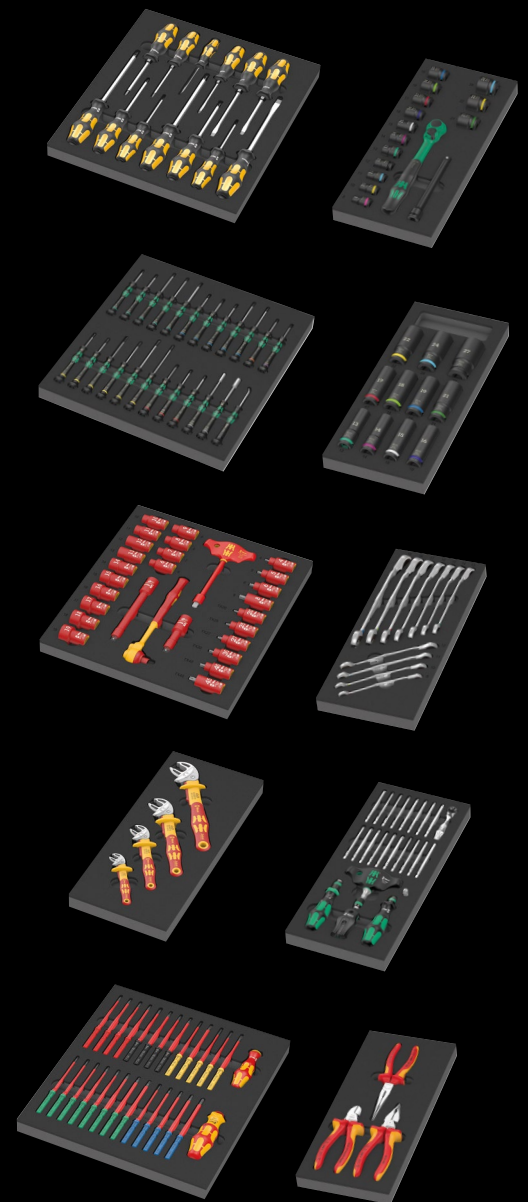

## Carrello da officina attrezzato con un Front Design geniale in qualità eccellente.

- Esclusivo carrello da officina nel Tool Rebel Design
- Versione estremamente robusta grazie alla costruzione a doppia parete
- Con 7 cassette (5 piatte, 2 alte) di cui 2 piatte con termoformati in spugna e dotazione utensili
- Misure cassetto piatto (largh. x alt. x prof.): 522 x 81 x 398 mm
- Misure cassetto alto (largh. x alt. x prof.): 522 x 166 x 398 mm
- 100% cassetto estraibile con guide telescopiche su cuscinetti a sfera, chiusura automatica
- Tutti i frontali dei cassette sono ricoperti da una pellicola elaborata
- Minimo rischio di ribaltamento grazie alla serratura estraibile – è possibile aprire un solo cassetto, nessun estrazione simultanea di più cassette
- Termoformati in spugna di elevata qualità, durevoli, senza vapori chimici
- Ottima adattabilità per prelevare al meglio gli utensili dai termoformati





**9700 Carrello da officina Tool Rebel 1**



Carrello da officina esclusivo in Tool Rebel Design. 5 cassetti piatti e 2 cassetti alti garantiscono una efficiente organizzazione mobile di utensili e materiale. Versione estremamente robusta a doppia parete e costruzione interamente saldata del corpo. Per il duro lavoro quotidiano. Dotato di 4 termoformati in spugna: 9710 termoformato giravite Set 1, 9720 termoformato cricchetto Zyklon 8000 A Set 1, 9731 termoformato chiavi a forchetta Joker 6003 Set 1, 9740 termoformato per chiavi piegate a L Set 1.

05150130001 1x 9700 Carrello da officina Tool Rebel 1

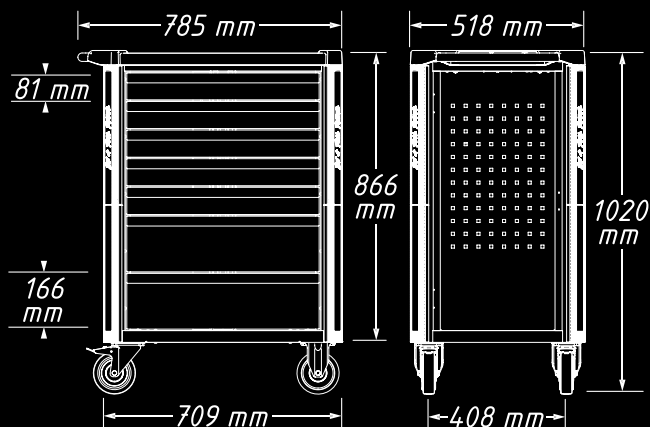

**Compresi i seguenti termoformati:**

**9710**



**9720**

**1/4"**

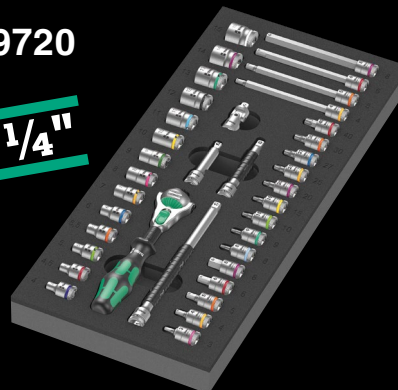

**9731**

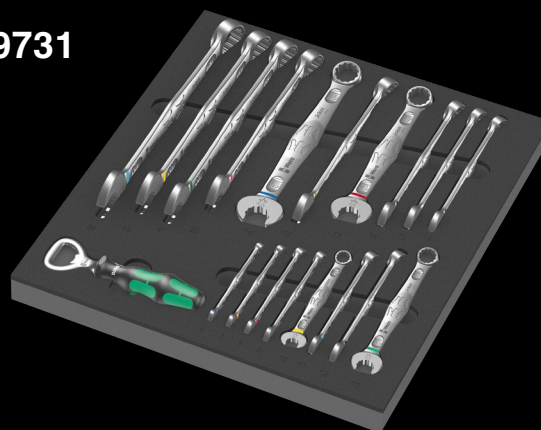

**9740**



## NUOVO

### 9714 Termoformato in spugna giravite a scalpello Set 1

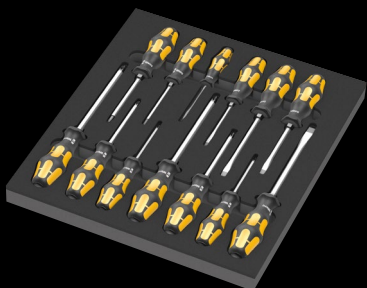

05150105001		
+	917 SPH	1x PH 1x80; 1x PH 2x100; 1x PH 3x150
+	918 SPZ	1x PZ 1x80; 1x PZ 2x100; 1x PZ 3x150
-	932 A	1x 0,6x3,5x80 <sup>1)</sup> ; 1x 0,8x4,5x90; 1x 1,0x5,5x100; 1x 1,2x7,0x125; 1x 1,6x9,0x150
+	977 TORX®	1x TX 20x90; 1x TX 25x100
	9814	1x 344,0x30,0x392,0

<sup>1)</sup> Lama: non passante, senza scudo, senza attacco per chiave di manovra

## NUOVO

### 9715 Termoformato in spugna giravite Kraftform Micro Set 1

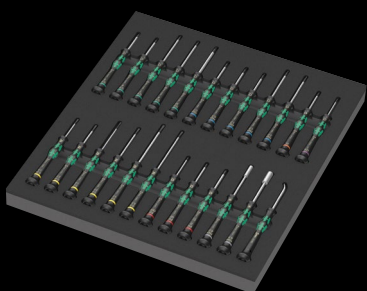

05150106001		
+	2050 Micro	1x PH 000x40 <sup>1) 2)</sup> ; 1x PH 00x40 <sup>1) 2)</sup> ; 1x PH 0x40 <sup>3)</sup>
+	2067 TORX® HF	1x TX 5x40; 1x TX 6x40; 1x TX 7x60; 1x TX 8x60; 1x TX 10x60
+	2067 TORX PLUS® IPR Micro	1x 1 IPRx40 <sup>4)</sup>
+	2072 Micro	1x mx40
+	2054 Micro	1x 0,7x40; 1x 0,9x40; 1x 1,3x40; 1x 1,5x60; 1x 2x60
-	2035 Micro	1x 0,23x1,5x40; 1x 0,30x1,8x60; 1x 0,35x2,5x40; 1x 0,40x2,0x60; 1x 0,40x2,5x80; 1x 0,50x3,0x80
+	2069 Micro	1x 4,0x60; 1x 5,5x60
+	1429	1x 1,0x3,5x50
	9815	1x 344,0x30,0x392,0

<sup>1)</sup> Ottimizzato per le viti asiatiche con impronta PH

<sup>2)</sup> Lama rettificata a valore nominale per una lunghezza di 10 mm lato profilo/impronta.

<sup>3)</sup> Misura 0 secondo JCS 0 (Japanese Camera Industrial Standard) modificata

<sup>4)</sup> Senza foratura

## NUOVO

### 9726 Termoformato in spugna cricchetto 8007 B VDE Zyklop VDE Set 1, 3/8"



05150116001		
+	8007 B VDE	1x 3/8"x222,0
+	410 i VDE B	1x 3/8"x130
+	8790 B VDE	1x 6,0x46,0; 1x 7,0x46,0; 1x 8,0x46,0; 1x 9,0x46,0; 1x 10,0x46,0; 1x 11,0x46,0; 1x 12,0x46,0; 1x 13,0x46,0; 1x 14,0x46,0; 1x 15,0x46,0; 1x 16,0x46,0; 1x 17,0x46,0; 1x 18,0x46,0; 1x 19,0x46,0
+	8767 B VDE HF	1x TX 20x55,0; 1x TX 25x55,0; 1x TX 27x55,0; 1x TX 30x55,0; 1x TX 40x55,0; 1x TX 45x59,0
+	8740 B VDE HF	1x 4,0x55,0; 1x 5,0x55,0; 1x 6,0x55,0; 1x 8,0x59,0
+	8794 SB VDE	1x 3/8"x91,0
+	8794 LB VDE	1x 3/8"x166,0
	9826	1x 344,0x30,0x392,0

## NUOVO

### 9734 Termoformato in spugna Joker 6004 VDE Set 1



05150124001		
	6004 Joker VDE XS	1x 7-10 (1/4"-3/8")x119
	6004 Joker VDE S	1x 10-13 (7/16"-1/2")x155
	6004 Joker VDE M	1x 13-16 (1/2"-5/8")x190
	6004 Joker VDE L	1x 16-19 (5/8"-3/4")x226
	9834	1x 172,0x30,0x392,0

Attenzione: i termoformati non sono compatibili con il modello precedente di carrello 05501051001

## NUOVO

### 9751 Termoformato in spugna Kraftform Kompakt VDE Set 1

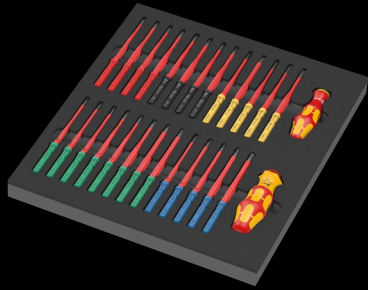

05150151001		
●	837 i RA	1x 9x115
●	817 VDE	1x 9x98
⊕	Kraftform Kompakt VDE 62 iS Take it easy	1x PH 1x157; 1x PH 2x157
⊕	Kraftform Kompakt VDE 65 iS Take it easy	1x PZ 1x157; 1x PZ 2x157
⊕	Kraftform Kompakt VDE 62 iS PH/S Take it easy	1x # 1x157; 1x # 2x157
⊕	Kraftform Kompakt VDE 65 iS PZ/S Take it easy	1x # 1x157; 1x # 2x157
⊕	Kraftform Kompakt VDE 67 i Take it easy	1x TX 8x157; 1x TX 9x157; 1x TX 10x157; 1x TX 27x157; 1x TX 30x157
⊕	Kraftform Kompakt VDE 67 iS Take it easy	1x TX 15x157; 1x TX 20x157; 1x TX 25x157
○	Kraftform Kompakt VDE 64 i Take it easy	1x 2,5x157; 1x 3,0x157; 1x 4,0x157; 1x 5,0x157; 1x 6,0x157
⊖	Kraftform Kompakt VDE 60 iS Take it easy	1x 0,6x3,5x157; 1x 0,8x4,0x157; 1x 1,0x5,5x157
⊖	Kraftform Kompakt VDE 60 i Take it easy	1x 0,4x2,5x157; 1x 1,2x6,5x157
	9851	1x 344,0x30,0x392,0

## NUOVO

### 9724 Termoformato in spugna cricchetto 8010 B Zyklop Comfort Set 1, 3/8"



3/8"



05150114001		
○	8010 B	1x 3/8"x230,0
●	8790 B Impaktör	1x 8,0x30,0; 1x 10,0x30,0; 1x 11,0x30,0; 1x 12,0x30,0; 1x 13,0x30,0; 1x 14,0x30,0; 1x 15,0x30,0; 1x 16,0x30,0; 1x 17,0x30,0; 1x 18,0x30,0; 1x 19,0x30,0; 1x 21,0x32,0; 1x 22,0x32,0; 1x 24,0x32,0
●○	8798 B	1x 3/8"x152,4
	9824	1x 172,0x30,0x392,0

## NUOVO

### 9725 Termoformato in spugna Zyklop C, 1/2", chiavi a bussola Impaktör Deep Set 1



05150115001		
●	8790 C Impaktör Deep	1x 13,0x83,0; 1x 14,0x83,0; 1x 15,0x83,0; 1x 16,0x83,0; 1x 17,0x83,0; 1x 18,0x83,0; 1x 19,0x83,0; 1x 21,0x83,0; 1x 22,0x83,0; 1x 24,0x83,0; 1x 27,0x83,0
	9825	1x 172,0x30,0x392,0

## NUOVO

### 9733 Termoformato in spugna Joker 6001 Switch Set 1

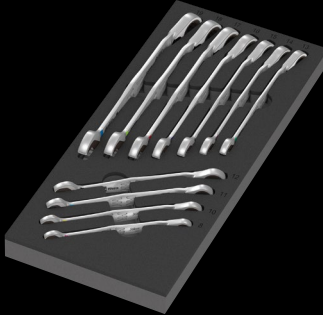

05150123001	
6001 Joker Switch	1x 8x144; 1x 10x159; 1x 11x165; 1x 12x171; 1x 13x179; 1x 14x187; 1x 15x199; 1x 16x213; 1x 17x225; 1x 18x234; 1x 19x246
9833	1x 172,0x30,0x392,0

## NUOVO

### 9784 Termoformato in spugna pinze KNIPEX Set VDE 1



05150184001	
Tronchese KNIPEX 70 06 160	
Pinza a becchi mezzotondi con tronchese (a becchi di cicogna) KNIPEX 26 16 200	
Pinza combinata a punta KNIPEX 08 26 185	
9884	1x 172,0x30,0x392,0

## NUOVO

### 9752 Termoformato in spugna Kraftform Kompakt con funzione cricchetto Set 1



1/4"

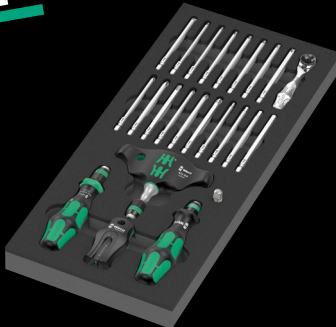

05150152001	
838 RA-R M	1x 1/4"x123,5
416 RA	1x 1/4"x45
816 R	1x 1/4"x119
8001 A	1x 1/4"x87,0
851/4 Z	1x PH 1x89; 1x PH 2x89; 1x PH 3x89 <sup>1)</sup>
855/4 Z	1x PZ 1x89; 1x PZ 2x89; 1x PZ 3x89 <sup>1)</sup>
867/4 Z TORX®	1x TX 10x89; 1x TX 15x89; 1x TX 20x89; 1x TX 25x89; 1x TX 27x89; 1x TX 30x89; 1x TX 40x89
840/4 Z	1x 3,0x89; 1x 4,0x89; 1x 5,0x89; 1x 6,0x89 <sup>1)</sup>
800/4 Z	1x 1,0x5,5x89
870/1	1x 1/4"x25 <sup>2)</sup>
9500	1x 64,6
9852	1x 172,0x30,0x392,0

### 9710 Termoformato in spugna giravite Set 1



05150101001	
932 A	1x 1,0x5,5x100; 1x 1,2x7,0x125
350 PH	1x PH 1x80; 1x PH 2x100; 1x PH 3x150
350 PH Giravite nano per viti a croce	1x PH 2x25
355 PZ	1x PZ 1x80; 1x PZ 2x100
335	1x 0,8x4,0x100; 1x 1,0x5,5x125
334	1x 1,2x6,5x150
335 Giravite nano	1x 1,0x5,5x24,5
2050 Micro	1x PH 0x40 <sup>1)</sup>
2035 Micro	1x 0,40x2,5x80
160 i VDE	1x 0,4x2,5x80 <sup>2)</sup> ; 1x 0,6x3,5x100 <sup>2)</sup>
1441	1x 4,5-6,0x41,0
1442	1x 6,0-8,5x41,0
9810	1x 344,0x30,0x392,0

<sup>1)</sup> Misura 0 secondo JCS 0 (Japanese Camera Industrial Standard) modificata

<sup>2)</sup> senza Lasertip

<sup>1)</sup> Lama esagonale

<sup>2)</sup> Con sfera; per bussole manuali

## 9711 Termoformato in spugna giravite isolati VDE Set 1

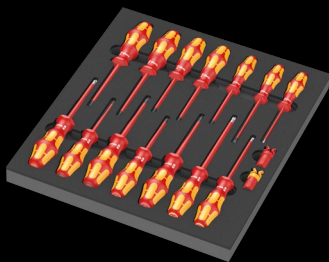

05150102001	
+	<b>162 iS PH VDE</b> 1x PH 1x80; 1x PH 2x100
+	<b>165 iS PZ VDE</b> 1x PZ 1x80; 1x PZ 2x100
+	<b>165 i PZ/S VDE</b> 1x # 2x100
-	<b>160 i VDE</b> 1x 0,4x2,5x80 <sup>1)</sup> ; 1x 0,8x4,0x100; 1x 1,0x5,5x125
-	<b>160 iS VDE</b> 1x 0,6x3,5x100
+	<b>167 i TORX® VDE</b> 1x TX 10x80; 1x TX 15x80; 1x TX 20x80; 1x TX 25x100; 1x TX 30x100
	<b>1440</b> 1x 4,5-6,0x41,0
	<b>1442</b> 1x 6,0-8,5x41,0
	<b>9811</b> 1x 344,0x30,0x392,0

<sup>1)</sup> senza Lasertip

## 9713 Termoformato in spugna giravite esagonali Hex Set 1

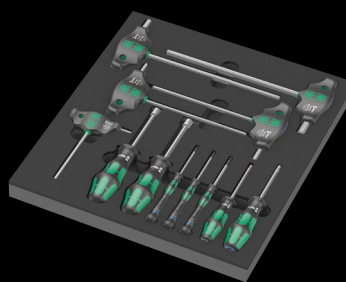

05150104001	
○	<b>354</b> 1x 3,0x75; 1x 4,0x75
○	<b>2054 Micro</b> 1x 1,5x60; 1x 2x60; 1x 2,5x60
○	<b>454 HF</b> 1x 4x100; 1x 5x100; 1x 6x150; 1x 8x200; 1x 10x200
●	<b>395 H0</b> 1x 10,0x90; 1x 13,0x90
	<b>9813</b> 1x 344,0x30,0x392,0

## 9720 Termoformato in spugna cricchetto Zyklop 8000 A 1/4" Set 1



## 9712 Termoformato in spugna giravite TORX® HF Set 1

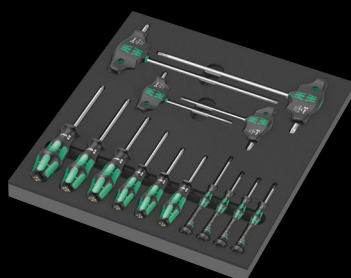

05150103001	
+	<b>367 TORX® HF</b> 1x TX 8x60; 1x TX 9x60; 1x TX 10x80; 1x TX 15x80; 1x TX 20x100; 1x TX 25x100
+	<b>2067 TORX® HF</b> 1x TX 4x40; 1x TX 5x40; 1x TX 6x40; 1x TX 7x60
+	<b>467 TORX® HF</b> 1x TX 20x100; 1x TX 25x100; 1x TX 30x200; 1x TX 40x200
	<b>9812</b> 1x 344,0x30,0x392,0

05150110001	
○	<b>8000 A</b> 1x 1/4"x152,0
●○	<b>8794 LA</b> 1x 1/4"x150,0
●○	<b>8794 SA</b> 1x 1/4"x75,0
●○	<b>8795 A</b> 1x 1/4"x35,5
●○	<b>8794 A</b> 1x 1/4"x56,0
●	<b>8790 HMA</b> 1x 4,0x23,0; 1x 4,5x23,0; 1x 5,0x23,0; 1x 5,5x23,0; 1x 6,0x23,0; 1x 7,0x23,0; 1x 8,0x23,0; 1x 9,0x23,0; 1x 10,0x23,0; 1x 11,0x23,0; 1x 12,0x23,0; 1x 13,0x23,0; 1x 14,0x23,0; 1x 15,0x23,0
+	<b>8767 A HF</b> 1x TX 8x28,0; 1x TX 9x28,0; 1x TX 10x28,0; 1x TX 15x28,0; 1x TX 20x28,0; 1x TX 25x28,0; 1x TX 27x28,0; 1x TX 30x28,0; 1x TX 40x28,0
○	<b>8740 A HF</b> 1x 3,0x28,0; 1x 4,0x28,0; 1x 4,0x100,0; 1x 5,0x28,0; 1x 5,0x100,0; 1x 6,0x28,0; 1x 6,0x100,0; 1x 8,0x28,0; 1x 8,0x100,0
	<b>9820</b> 1x 172,0x30,0x392,0



## 9721 Termoformato in spugna cricchetto Zyklop 8000 B 3/8" Set 1



05150111001		
○	8000 B	1x 3/8"x199,0
●○	8794 SB	1x 3/8"x125,0
●○	8794 LB	1x 3/8"x200,0
●○	8795 B	1x 3/8"x50,0
●○	8794 B	1x 3/8"x76,0
●	8790 HMB	1x 6,0x29,0; 1x 7,0x29,0; 1x 8,0x29,0; 1x 9,0x29,0; 1x 10,0x29,0; 1x 11,0x29,0; 1x 12,0x29,0; 1x 13,0x29,0; 1x 14,0x29,0; 1x 15,0x29,0; 1x 16,0x30,0; 1x 17,0x30,0; 1x 18,0x30,0; 1x 19,0x30,0; 1x 20,0x30,0; 1x 21,0x30,0; 1x 22,0x30,0; 1x 24,0x32,0
	9821	1x 172,0x30,0x392,0

## 9723 Termoformato in spugna bussole Zyklop B 3/8" Set 1



05150113001		
●●	8784 B1	1x 1/4"x3/8"x44,0
⊗	8767 B HF	1x TX 15x35,0; 1x TX 20x35,0; 1x TX 25x35,0; 1x TX 25x107,0; 1x TX 27x35,0; 1x TX 27x107,0; 1x TX 30x35,0; 1x TX 30x107,0; 1x TX 40x35,0; 1x TX 40x107,0
○	8740 B HF	1x 4,0x35,0; 1x 4,0x107,0; 1x 5,0x35,0; 1x 5,0x107,0; 1x 6,0x35,0; 1x 6,0x107,0; 1x 7,0x38,5; 1x 8,0x38,5; 1x 8,0x100,0; 1x 10,0x38,5; 1x 10,0x100,0
	9823	1x 172,0x30,0x392,0

## 9722 Termoformato in spugna cricchetto Zyklop 8000 C 1/2" Set 1



05150112001		
○	8000 C	1x 1/2"x277,0
●○	8794 LC	1x 1/2"x250,0
●○	8794 SC	1x 1/2"x125,0
●○	8795 C	1x 1/2"x69,0
●○	8794 C	1x 1/2"x52,0
●	8790 HMC	1x 10,0x37,0; 1x 11,0x37,0; 1x 12,0x37,0; 1x 13,0x37,0; 1x 14,0x37,0; 1x 15,0x37,0; 1x 16,0x37,0; 1x 17,0x37,0; 1x 18,0x37,0; 1x 19,0x37,0; 1x 20,0x37,0; 1x 21,0x37,0; 1x 22,0x37,0; 1x 24,0x37,0; 1x 27,0x40,0; 1x 30,0x42,0; 1x 32,0x42,0
○	8740 C HF	1x 4,0x60,0; 1x 4,0x140,0; 1x 5,0x60,0; 1x 5,0x140,0; 1x 6,0x60,0; 1x 6,0x140,0; 1x 7,0x60,0; 1x 8,0x60,0; 1x 10,0x60,0
	9822	1x 344,0x30,0x392,0

## 9730 Termoformato in spugna 6000 Joker Set 1

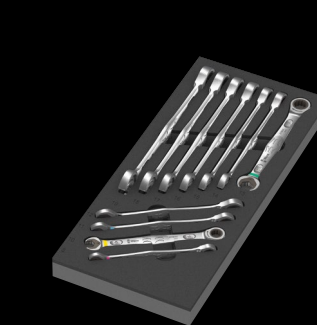

05150120001		
	6000 Joker	1x 8x144; 1x 10x159; 1x 11x165; 1x 12x170,7; 1x 13x177; 1x 14x188; 1x 15x200; 1x 16x212; 1x 17x224; 1x 18x235; 1x 19x246
	9830	1x 172,0x30,0x392,0

## 9731 Termoformato in spugna 6003 Joker Set 1



05150121001		
	<b>6003 Joker</b>	1x 6x105; 1x 7x110; 1x 8x115; 1x 9x120; 1x 10x125; 1x 11x135; 1x 12x148; 1x 13x160; 1x 14x167; 1x 15x174; 1x 16x182; 1x 17x190; 1x 18x210; 1x 19x230,0; 1x 20x230,0; 1x 21x260; 1x 22x260; 1x 24x280
	<b>Apribottiglie</b>	1x 148
	<b>9831</b>	1x 344,0x30,0x392,0

## 9732 Termoformato in spugna 6004 Joker Set 1



05150122001		
	<b>6004 Joker XS</b>	1x 7-10 (1/4"-3/8")x117
	<b>6004 Joker S</b>	1x 10-13 (7/16"-1/2")x154
	<b>6004 Joker M</b>	1x 13-16 (1/2"-5/8")x188
	<b>6004 Joker L</b>	1x 16-19 (5/8"-3/4")x224
	<b>6004 Joker XL</b>	1x 19-24x (3/4"-15/16")x256
	<b>9832</b>	1x 172,0x30,0x392,0

## 9740 Termoformato in spugna Chiavi piegate a L Set 1



## 9750 Termoformato in spugna Kraftform Kompakt e Tool-Check PLUS Set 1



05150150001		
	<b>1x Tool-Check PLUS</b>	
	● <b>8001 A</b>	1x 1/4"x87.0
	● <b>813</b>	1x 1/4"x78
	● <b>889/4/1 K</b>	1x 1/4"x50
	○ <b>870/1</b>	1x 1/4"x25 <sup>1)</sup>
	● <b>8790 HMA</b>	1x 5.5x23.0; 1x 6.0x23.0; 1x 7.0x23.0; 1x 8.0x23.0; 1x 10.0x23.0; 1x 12.0x23.0; 1x 13.0x23.0
	⊕ <b>851/1 TZ</b>	2x PH 1x25; 3x PH 2x25; 1x PH 3x25
	⊕ <b>855/1 TH</b>	1x PZ 1x25; 3x PZ 2x25; 1x PZ 3x25
	⊕ <b>867/1 TZ TORX®</b>	1x TX 10x25; 1x TX 15x25; 1x TX 20x25; 1x TX 25x25; 1x TX 30x25; 1x TX 40x25
	⊕ <b>867/1 Z TORX® BO</b>	1x TX 10x25; 1x TX 15x25; 1x TX 20x25; 1x TX 25x25; 1x TX 30x25
	○ <b>840/1 Z</b>	1x 3.0x25; 1x 4.0x25; 1x 5.0x25; 1x 6.0x25; 1x 8.0x25
	⊖ <b>800/1 TZ</b>	1x 1.0x5.5x25
	<b>1x Kraftform Kompakt 60</b>	
	● <b>816 R</b>	1x 1/4"x119
	⊕ <b>851/4 Z</b>	1x PH 1x89; 1x PH 2x89; 1x PH 3x89 <sup>2)</sup>
	⊕ <b>855/4 Z</b>	1x PZ 1x89; 1x PZ 2x89; 1x PZ 3x89 <sup>2)</sup>
	⊕ <b>867/4 Z TORX® BO</b>	1x TX 10x89; 1x TX 15x89; 1x TX 20x89; 1x TX 25x89; 1x TX 30x89
	⊖ <b>800/4 Z</b>	1x 1.0x5.5x89
	○ <b>840/4 Z</b>	1x 3.0x89; 1x 4.0x89; 1x 5.0x89; 1x 6.0x89 <sup>2)</sup>
	<b>Nastro autoaderente 70</b>	1x 50.0x70.0
	<b>1x 393 S</b>	
	●	1x 1/4"x173,5
	<b>1x 9850</b>	
		1x 172,0x30,0x392,0

<sup>1)</sup> Con sfera; per bussole manuali

<sup>2)</sup> Lama esagonale

05150140001		
	<b>1x 950/9 Hex-Plus Multicolour 1</b>	
	○ <b>950 SPKL Multicolour</b>	1x 1.5x90; 1x 2.0x101; 1x 2.5x112; 1x 3.0x123; 1x 4.0x137; 1x 5.0x154; 1x 6.0x172; 1x 8.0x195; 1x 10.0x224
	<b>1x 967/9 TX XL Multicolour 1</b>	
	⊕ <b>967 SXL TORX® Multicolour</b>	1x TX 8x90; 1x TX 9x101; 1x TX 10x112
	⊕ <b>967 SPKXL TORX® Multicolour</b>	1x TX 15x123; 1x TX 20x137; 1x TX 25x154; 1x TX 27x172; 1x TX 30x195; 1x TX 40x224
	<b>1x 9500</b>	
		1x 64,6
	<b>1x Flessometro BM 100, scala metrica graduata, STABILA®, 3 m, articolo 19570</b>	
		1x 3000,0
	<b>1x 9840</b>	
		1x 172,0x30,0x392,0

### 9780 Termoformato in spugna pinze KNIPEX Set 1

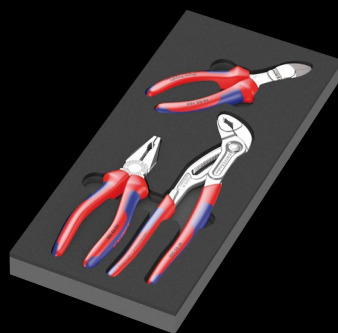

05150180001	
KNIPEX Pinza universale 03 05 180	1x 180
KNIPEX Cobra® Pinza regolabile di nuova generazione per tubi e dadi 87 05 250	1x 250
KNIPEX Tronchese laterale per meccanica tipo forte 74 05 160	1x 160
9880	1x 172,0x30,0x392,0

### 9782 Termoformato in spugna martello Set 1



05150182001	
PICARD® Martello da fabbro 500 g, 0000101-500	1x 500,0
RENNSTEIG Cacciaspines Esklusiv	1x 452 003 6 RC, 3,0x150; 1x4520046RC, 4,0x150; 1x4520066RC, 6,0x150; 1x 452 008 6 RC, 8,0x150
RENNSTEIG Scalpello piatto 310 250 1	1x 25,0x13,0x23,0
9882	1x 172,0x30,0x392,0

### 9783 Termoformato in spugna lime PFERD Set 1

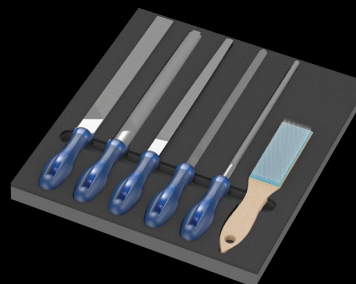

05150183001	
PFERD Lima per meccanica quadra PF1142 250 H2	1x 250
PFERD Lima per meccanica mezzotonda a punta 1152SP 250 H2	1x 250
PFERD Lima per meccanica tonda 1162 250 H2	1x 250
PFERD Lima per meccanica piatta 1112 250 H2	1x 250
PFERD Lima per meccanica triangolare 1132 250 H2	1x 250
PFERD Spazzola per lime HBF Filo d'acciaio Ø 0,15	1x 232
9883	1x 344,0x30,0x392,0

### 9781 Termoformato in spugna pinze KNIPEX Set 2

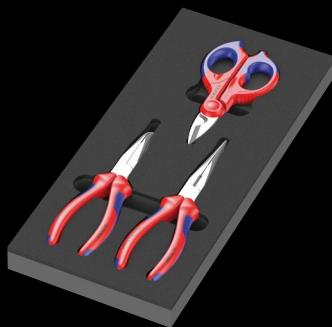

05150181001	
KNIPEX Pinza per meccanica con becchi mezzotondi con tronchese (pinza a becchi di cicogna) 26 15 200	1x 200
KNIPEX Pinza per meccanica 38 25 200	1x 200
KNIPEX Forbicie da elettricista 95 05 155	1x 155
9881	1x 172,0x30,0x392,0

Ci riserviamo il diritto di modificare, in qualsiasi momento e senza preavviso, tutti i dati riportati in questo catalogo relativi alle caratteristiche, ai tipi e ai modelli dei prodotti. Decliniamo ogni responsabilità per eventuali inesattezze ed errori di stampa.



Wera Werkzeuge GmbH  
Korzter Straße 21-25  
D-42349 Wuppertal

Phone: +49 (0)2 02/40 45-0  
E-Mail: [info@wera.de](mailto:info@wera.de)  
[www.wera.de](http://www.wera.de)



IT 05 510246 024 - 0053701 - 01